

CATALOGUE NUMBER: P10.50.2-120

Trouble free cutting of edge gate inside the mould during mould opening.

Large edge gate to improve mould fill and packing.

Reduces injection pressure and moulding cycle.

Economical interchangeable cutting insert.

Manufactured from M2 64 HRC.

Metric and inch sizes.

Easy to install.

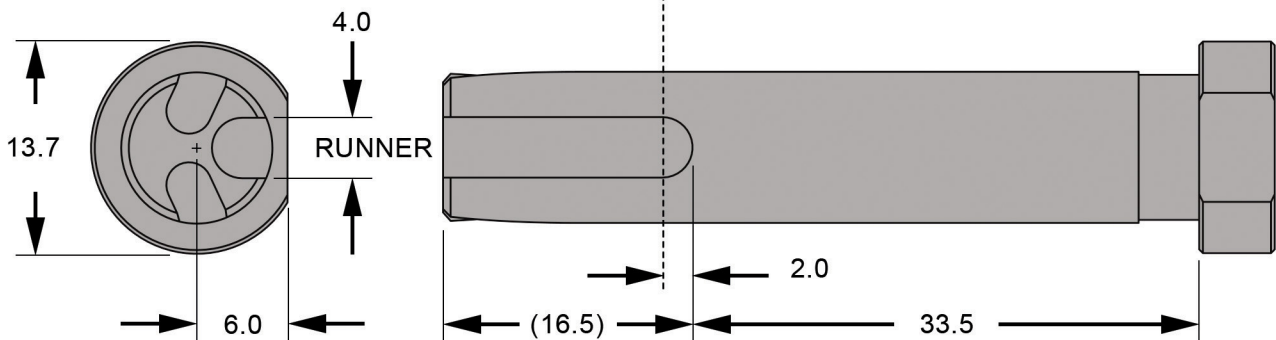
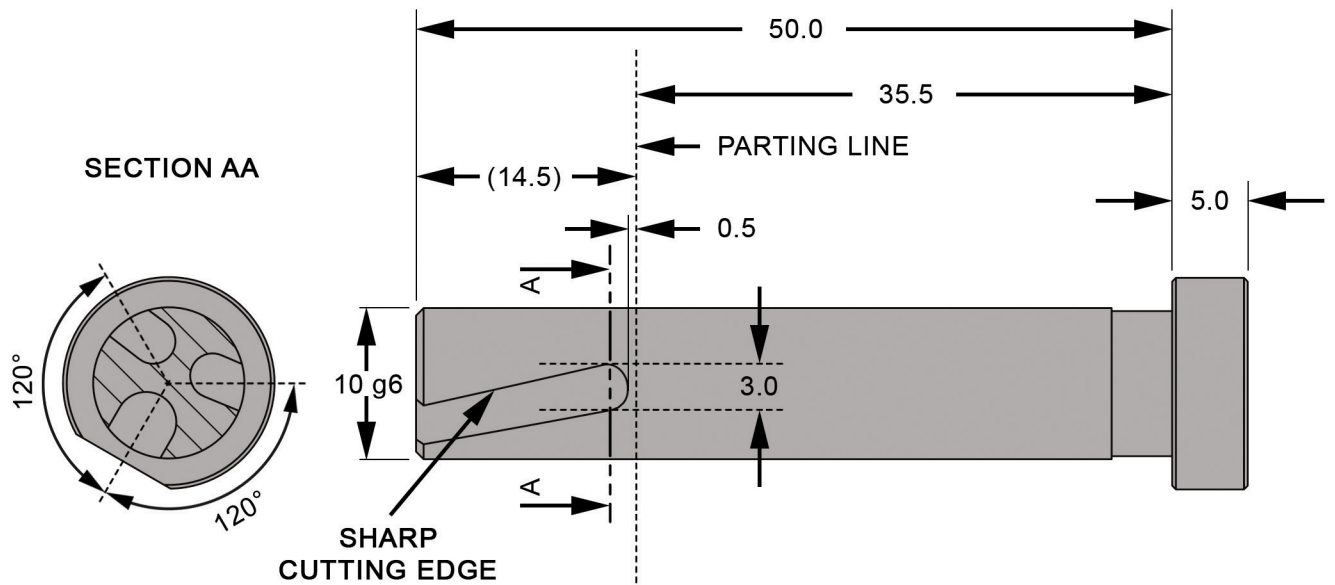
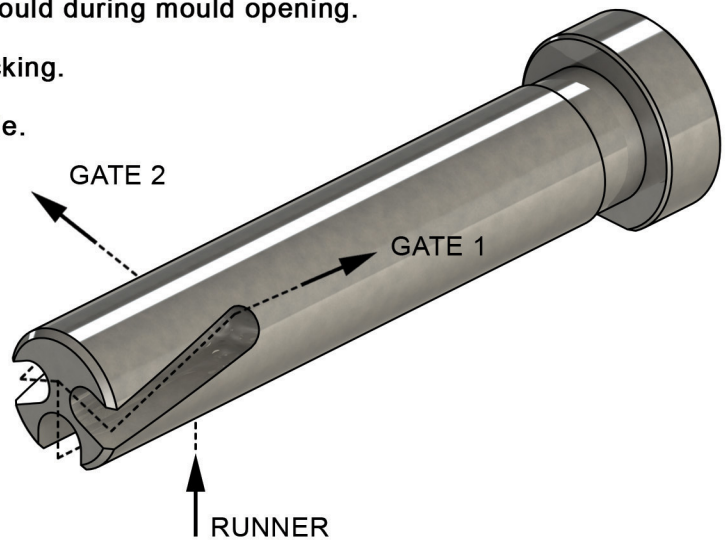

\*Ejector plate must be held back during mould opening time.

PATENTED PRODUCT